



IMA

AUDIO LIGHTING

Price List
2022-....



P series

ΒΑΣΕΙΣ-ΚΡΕΜΑΣΤΙΚΑ





ΒΑΣΕΙΣ & ΕΞΑΡΤΗΜΑΤΑ P SERIES

| | |
|----------------|--|
| > VNI-WM200 | |
| > VNI-WM200-PW | |
| > VNI-WM280 | |
| > VNI-WM280-PW | |
| > VNI-WM330 | |
| > VNI-WM330-PW | |
| > VNI-WM380 | |
| > VNI-WM380-PW | |

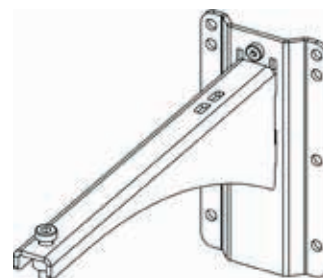

- > **VNI-WM200:** Βάση τοίχου **200MM** για ID84, **P8** και EPS6.
- > **VNI-WM200-PW:** VNI-WM200 **ΛΕΥΚΗ**.
- > **VNI-WM280:** Βάση τοίχου **280MM** για **P10** και EPS8.
- > **VNI-WM280-PW:** VNI-WM280 **ΛΕΥΚΗ**.
- > **VNI-WM330:** Βάση τοίχου **330MM** για **P12** και EPS10.
- > **VNI-WM330-PW:** VNI-WM330 **ΛΕΥΚΗ**.
- > **VNI-WM380:** Βάση τοίχου **380MM** για **P15**.
- > **VNI-WM380-PW:** VNI-WM380 **ΛΕΥΚΗ**.

| | |
|-----------------|--|
| > PNU-VBRK8 | |
| > PNU-VBRK8-PW | |
| > PNU-VBRK10 | |
| > PNU-VBRK10-PW | |
| > PNU-VBRK12 | |
| > PNU-VBRK12-PW | |
| > PNU-VBRK15 | |
| > PNU-VBRK15-PW | |

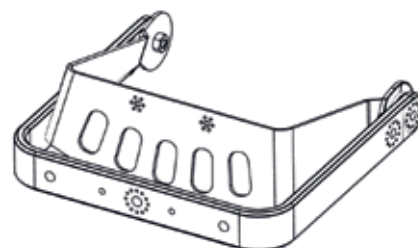

- > **PNU-VBRK8:** Βάση **ΚΑΘΕΤΗΣ** τοποθέτησης για **P8**.
- > **PNU-VBRK8-PW:** PNU-VBRK8 **ΛΕΥΚΗ**.
- > **PNU-VBRK10:** Βάση **ΚΑΘΕΤΗΣ** τοποθέτησης για **P10**.
- > **PNU-VBRK10-PW:** PNU-VBRK10 **ΛΕΥΚΗ**.
- > **PNU-VBRK12:** Βάση **ΚΑΘΕΤΗΣ** τοποθέτησης για **P12**.
- > **PNU-VBRK12-PW:** PNU-VBRK12 **ΛΕΥΚΗ**.
- > **PNU-VBRK15:** Βάση **ΚΑΘΕΤΗΣ** τοποθέτησης για **P15**.
- > **PNU-VBRK15-PW:** PNU-VBRK15 **ΛΕΥΚΗ**.

ΒΑΣΕΙΣ-ΚΡΕΜΑΣΤΙΚΑ

NEXO

> VNU-HBRK425

> VNU-HBRK425-PW

> VNU-HBRK500

> VNU-HBRK500 -PW

> VNU-HBRK535

> VNU-HBRK535-PW

> VNU-HBRK600

> VNU-HBRK600-PW

- > **VNU-HBRK425:** Βάση οριζόντιας τοποθέτησης **425MM** για **P8**, EPS8 και ELS400.
- > **VNU-HBRK425-PW:** VNU-HBRK425 **ΛΕΥΚΗ**.
- > **VNU-HBRK500:** Βάση οριζόντιας τοποθέτησης **500MM** για **P10**.
- > **VNU-HBRK500-PW:** VNU-HBRK500 **ΛΕΥΚΗ**.
- > **VNU-HBRK535:** Βάση οριζόντιας τοποθέτησης **535MM** για **P12**, EPS10 και ELS600.
- > **VNU-HBRK535-PW:** VNU-HBRK535 **ΛΕΥΚΗ**.
- > **VNU-HBRK600:** Βάση οριζόντιας τοποθέτησης **600MM** για **P15**.
- > **VNU-HBRK600-PW:** VNU-HBRK600 **ΛΕΥΚΗ**.

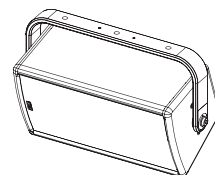

> LNU-HBRK15

> LNU-HBRK15-PW

> LNU-HBRK18

> LNU-HBRK18-PW

- > **LNU-HBRK15:** Βάση οριζόντιας τοποθέτησης για **L15**.
- > **LNU-HBRK15-PW:** LNU-HBRK15 **ΛΕΥΚΗ**.
- > **LNU-HBRK18:** Βάση οριζόντιας τοποθέτησης για **L18**.
- > **LNU-HBRK18-PW:** LNU-HBRK18 **ΛΕΥΚΗ**.



> VNI-WMADAPT

> VNI-WMADAPT-PW

- > **VNI-WMADAPT:** Ευπροσάρμοστος ανάπτορας βάσης τοίχου για σειρές ID, EPS και **P**.
- > **VNI-WMADAPT-PW:** VNI-WMADAPT **ΛΕΥΚΟΣ**.





ΣΥΣΤΗΜΑΤΑ ΑΝΑΡΤΗΣΗΣ P SERIES

| | | |
|--|--|--|
| > PNI-P12TOL15 | | |
| > PNI-P12TOL15-PW | | |
| > PNI-P12TOL15: Πλήρες σύστημα ανάρτησης για 1xP12 κάτω από 1xL15 . > PNI-P12TOL15-PW: PNI-P12TOL15 ΛΕΥΚΟ . | | |
| > PNI-P12TO2L15 | | |
| > PNI-P12TO2L15-PW | | |
| > PNI-P12TO2L15: Πλήρες σύστημα ανάρτησης για 1xP12 κάτω από 2xL15 . > PNI-P12TO2L15-PW: PNI-P12TO2L15 ΛΕΥΚΟ . | | |
| > PNI-P15TOL18 | | |
| > PNI-P15TOL18-PW | | |
| > PNI-P15TOL18: Πλήρες σύστημα ανάρτησης για 1xP15 κάτω από 1xL18 . > PNI-P15TOL18-PW: PNI-P15TOL18 ΛΕΥΚΟ . | | |
| > PNI-P15TO2L18 | | |
| > PNI-P15TO2L18-PW | | |
| > PNI-P15TO2L18: Πλήρες σύστημα ανάρτησης για 1xP15 κάτω από 2xL18 . > PNI-P15TO2L18-PW: PNI-P15TO2L18 ΛΕΥΚΟ . | | |
| > LNI-3L15 | | |
| > LNI-3L15-PW | | |
| > LNI-3L18 | | |
| > LNI-3L18-PW | | |
| > LNI-3L15: Πλήρες σύστημα ανάρτησης για 3 x L15 . > LNI-3L15-PW: LNI-3L15 ΛΕΥΚΟ . > LNI-3L18: Πλήρες σύστημα ανάρτησης για 3 x L18 . > LNI-3L18-PW: LNI-3L18 ΛΕΥΚΟ . | | |



ΕΞΑΡΤΗΜΑΤΑ P SERIES

> VNI-CLADAPT

> VNI-CLADAPT-PW

> **VNI-CLADAPT:** Στήριγμα τοποθέτησης σε οροφή για βάσεις.
 > **VNI-CLADAPT-PW:** VNI-CLADAPT **ΛΕΥΚΟ**.

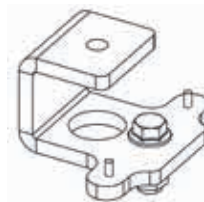

> VNU-BUMP

> VNU-BUMP-PW

> **VNU-BUMP:** Ευπροσάρμοστο **BUMPER** για EPS και **P SERIES**.
 > **VNU-BUMP-PW:** VNU-BUMP **ΛΕΥΚΟ**.

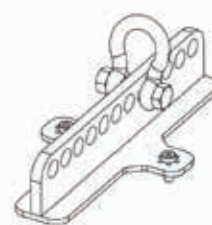

> VNT-LIFTADAPT

> VNT-LIFTADAPT-PW

> **VNT-LIFTADAPT:** Αντάπτορας **BUMPER** σε στήριγμα τράσας.
 > **VNT-LIFTADAPT-PW:** VNT-LIFTADAPT **ΛΕΥΚΟΣ**.

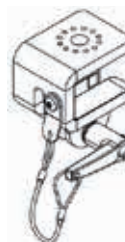

> VNU-PLADAPT

> VNU-PLADAPT-PW

> **VNU-PLADAPT:** Ευπροσάρμοστος αντάπτορας τοποθέτησης σε στήλη.
 > **VNU-PLADAPT-PW:** VNU-PLADAPT **ΛΕΥΚΟΣ**.

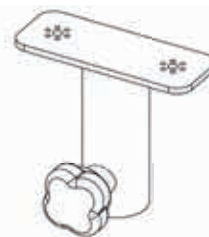

ΘΗΚΕΣ - ΚΑΛΥΜΜΑΤΑ P SERIES

> PNT-COV8

> PNT-COV10



> PNT-COV12

> PNT-COV15





> **PNT-COV8:** Θήκη προστασίας για **P8**.
 > **PNT-COV10:** Θήκη προστασίας για **P10**.
 > **PNT-COV12:** Θήκη προστασίας για **P12**.
 > **PNT-COV15:** Θήκη προστασίας για **P15**.





| | | |
|----------------------------------|--|---|
| > LNT-COV15 | |  |
| Θήκη προστασίας για L15 . | | |
| > LNT-COV18 | |  |
| Θήκη προστασίας για L18 . | | |

FLIGHT CASES & WHEELBOARDS P SERIES

| | | |
|--|--|---|
| > PNT-4CASE8 | |  |
| FLIGHT CASE για 4 X P8 . | | |
| > PNT-2CASE10 | |  |
| FLIGHT CASE για 2 X P10 . | | |
| > PNT-2CASE12 | |  |
| > PNT-2CASE15 | | |
| > PNT-2CASE12: FLIGHT CASE για 2 X P12 . > PNT-2CASE15: FLIGHT CASE για 2 X P15 . | | |
| > LNT-2CASE15 | |  |
| FLIGHT CASE για 2 X L15 . | | |
| > LNT-WB15 | |  |
| > LNT-WB18 | | |
| > LNT-WB15: WHEELBOARD για L15 . > LNT-WB18: WHEELBOARD για L18 . | | |

ΒΑΣΕΙΣ-ΚΡΕΜΑΣΤΙΚΑ

NEXO

> PNT-ACC8

> PNT-ACC10

> PNT-ACC12

> PNT-ACC15

- > **PNT-ACC8:** FLIGHT CASE για παρελκόμενα **P8 (ACCESSORIES)**.
- > **PNT-ACC10:** FLIGHT CASE για παρελκόμενα **P10 (ACCESSORIES)**.
- > **PNT-ACC12:** FLIGHT CASE για παρελκόμενα **P12 (ACCESSORIES)**.
- > **PNT-ACC15:** FLIGHT CASE για παρελκόμενα **P15 (ACCESSORIES)**.



ΧΟΑΝΕΣ P SERIES

> PNU-P8FLG11060

HF DISPERSION HORN **110°- 60°** για **P8**.



> PNU-P10FLG11060

HF DISPERSION HORN **110°- 60°** για **P10**.

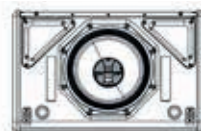

> PNU-P12FLG9040

> PNU-P12FLG9040-BK

- > **PNU-P12FLG9040:** HF DISPERSION HORN **90°- 40°** για **P12**.
- > **PNU-P12FLG9040-BK:** PNU-P12FLG9040 **MAYPH**.





> PNU-P12FLGPS

> PNU-P12FLGPS-BK

- > **PNU-P12FLGPS:** HF DISPERSION HORN **PS** για **P12**.
- > **PNU-P12FLGPS-BK:** PNU-P12FLGPS **MAYPH**.



| | | |
|--|--|---|
| > PNU-P15FLG9040 | |  |
| > PNU-P15FLG9040-BK | | |
| > PNU-P15FLG9040: HF DISPERSION HORN 90°- 40° για P15. > PNU-P15FLG9040-BK: PNU-P15FLG9040 MAYPH . | | |
| > PNU-P15FLGPS | |  |
| > PNU-P15FLGPS-BK | | |
| > PNU-P15FLGPS: HF DISPERSION HORN PS για P15 > PNU-P15FLGPS-BK: PNU-P15FLGPS MAYPH . | | |

SET ΑΝΑΡΤΗΣΗΣ P SERIES

| | | |
|--------------------|----------------------|---|
| > VNI-CLADAPT + | P8 > VNU-HBRK425 |  |
| | P10 > VNU-HBRK500 | |
| | P12 > VNU-HBRK535 | |
| | P15 > VNU-HBRK600 | |

| | | |
|--------------------|---------------------|---|
| > VNI-CLADAPT + | P8 > PNU-VBRK8 |  |
| | P10 > PNU-VBRK10 | |
| | P12 > PNU-VBRK12 | |
| | P15 > PNU-VBRK15 | |

ΒΑΣΕΙΣ-ΚΡΕΜΑΣΤΙΚΑ

NEXO

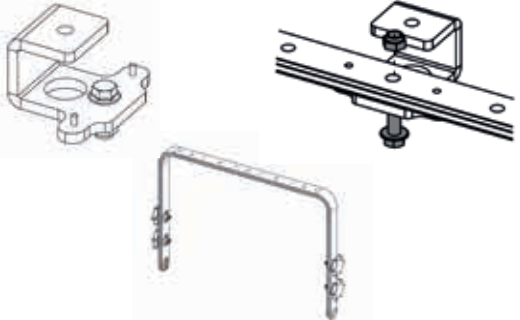
| | | |
|---------------------------|---------------------|--|
| 2 X > VNI-CLADAPT + | L15 > LNU-HBRK15 |  |
| | L18 > LNU-HBRK18 | |

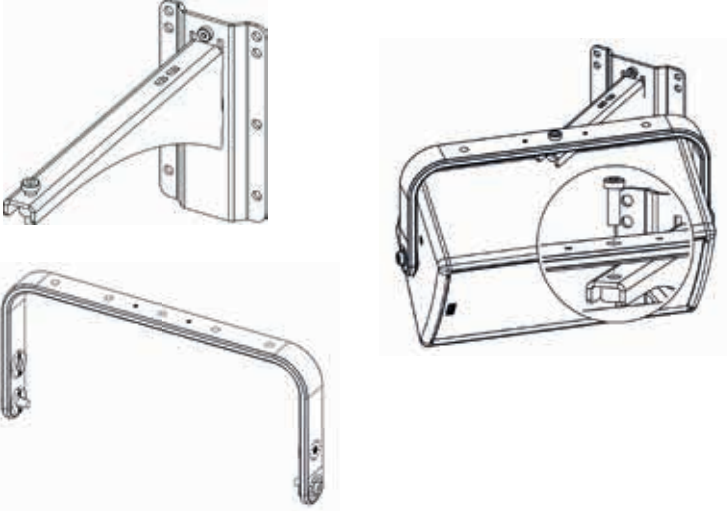
| | |
|-------------------------------------|---|
| P8 > VNU-HBRK425 > VNI-WM200 |  |
| P10 > VNU-HBRK500 > VNI-WM280 | |
| P12 > VNU-HBRK535 > VNI-WM330 | |
| P15 > VNU-HBRK600 > VNI-WM380 | |

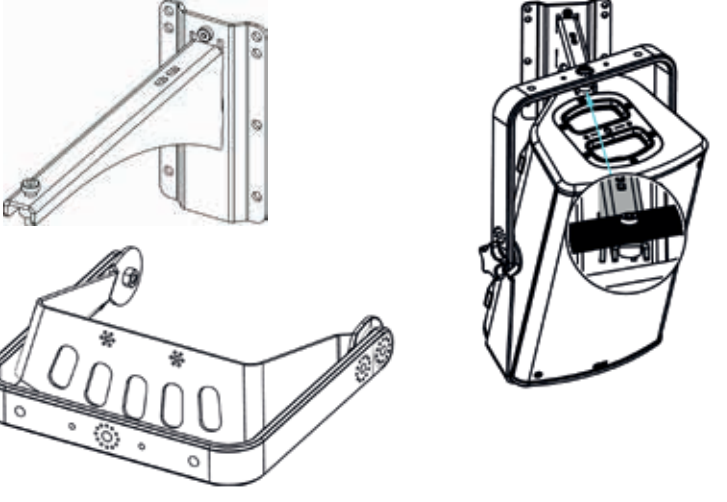
| | |
|------------------------------------|--|
| P8 > PNU-VBRK8 > VNI-WM200 |  |
| P10 > PNU-VBRK10 > VNI-WM280 | |
| P12 > PNU-VBRK12 > VNI-WM330 | |
| P15 > PNU-VBRK15 > VNI-WM380 | |

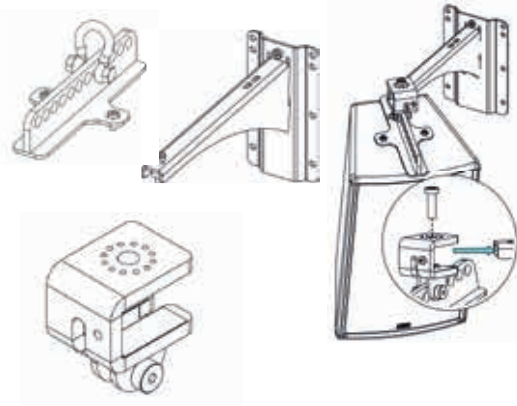

| | | | |
|---|-------------------------------------|--|--|
| > VNU-BUMP + > VNI-WMADAPT + | P8 > VNI-WM200 | |  |
| | P10 > VNI-WM280 | | |
| | P12 > VNI-WM330 | | |
| | P15 > VNI-WM380 | | |

| | | | |
|---------------------------|--------------------------------------|--|---|
| > VNU-PLADAPT + | P8 > PNU-VBRK8 | |  |
| | P10 > PNU-VBRK10 | | |
| | P12 > PNU-VBRK12 | | |
| | P15 > PNU-VBRK15 | | |

| | | | |
|---------------------------|---------------------------------------|--|--|
| > VNU-PLADAPT + | P8 > VNU-HBRK425 | |  |
| | P10 > VNU-HBRK500 | | |
| | P12 > VNU-HBRK535 | | |
| | P15 > VNU-HBRK600 | | |

IMA
AUDIO LIGHTING



Πωλήσεις και τεχνική υποστήριξη

www.ima.gr

Καποδιστρίου 12, Πλ. Κάνιγγος, Αθήνα

Τηλ: 210 3816813 - 210 3845678

em: ima@ima.gr